

Corrediza en línea:

Alto nivel de comodidad y optimización del espacio

El sistema de puertas y ventanas corredizas facilita un uso optimizado del espacio a la vez que ofrece comodidad gracias a su sistema de apertura mediante el deslizado de la hoja. In-line Sliding ofrece numerosas soluciones especialmente adaptadas a las necesidades del mercado.

Desde una hoja pequeña hasta una superficie de vidrio grande.

El principio modular de Roto permite numerosas opciones de diseño. Todos los componentes pueden combinarse fácilmente entre sí, de acuerdo con las necesidades individuales de seguridad, comodidad y diseño.

Gran variedad de productos para cubrir todas las necesidades.

Para cualquiera de las composiciones posibles escoja el nivel de seguridad que desee mediante los bulones de champiñón, gancho, picos de loro, etc.



Ruedas para cada necesidad

Las ruedas con una capacidad elevada de carga son la base para un deslizamiento elegante y sencillo de las hojas, ya que permiten un funcionamiento uniforme y suave. La gama de productos incluye ahora una versión regulable en altura y con rodamiento de aguja, adecuado para pesos de hoja de hasta 200 kg.



Nueva rueda para corrediza que posibilita un deslizamiento suave para hojas de hasta 200 kg.

Nueva familia de manillas para puertas y ventanas corredizas.

Las manillas de diseño elegante de RotoLine incorporan tecnología y diseño. Los componentes pre-montados permiten una instalación rápida y fácil.

La nueva línea de manillas, además, convence por su gran variedad: numerosas manillas están disponibles tanto para exterior como para interior, en diversos y atractivos colores.



Manillas exteriores: manilla con llave o versión de manilla más uñero

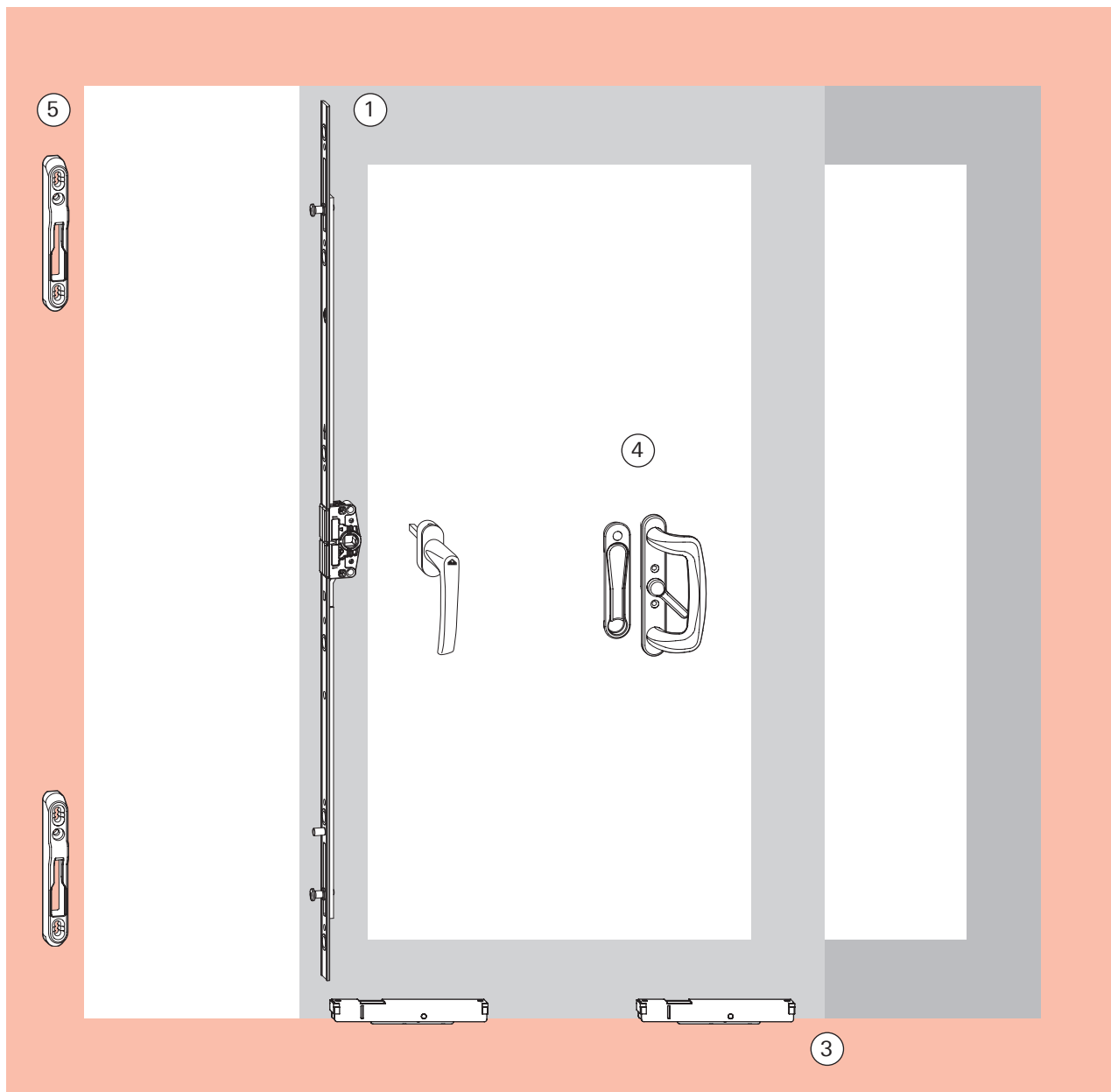

Nr.	Descripción	Ver página
1	Cremona	54
3	Rodamientos	55
4	Manilla	57, 59, 60
5	Cerraderos	60
	Accesorios	61

1. Cremonas

Acción simple con bulón ajustable

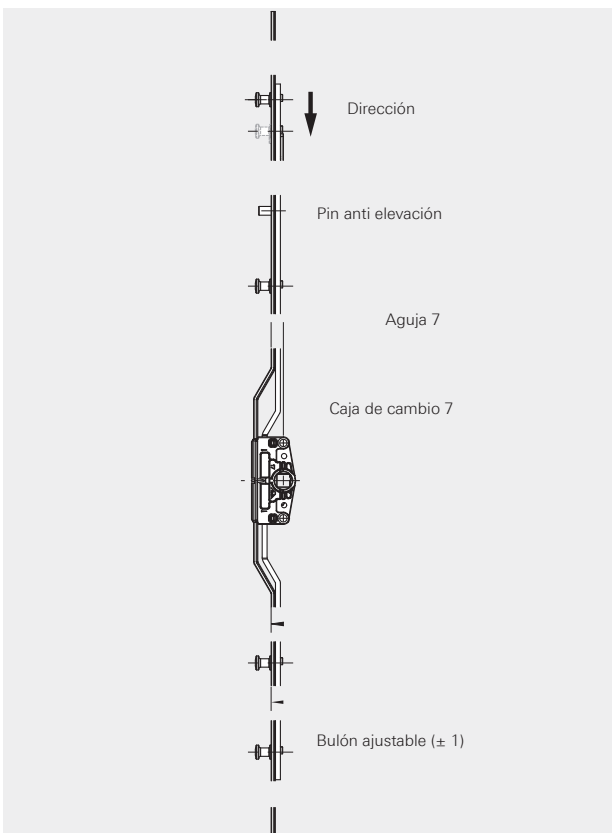

Cremona aguja 7 mm

Rango de aplicación/mm	Largo/mm	Bulones	Mat. Nr.
400 – 600	400	2	628 429
601 – 800	600	2	628 430
801 – 1000	800	2	628 431
1001 – 1200	1000	3	628 432
1201 – 1800	1200	3	628 433
1801 – 2900	1800	4	628 434

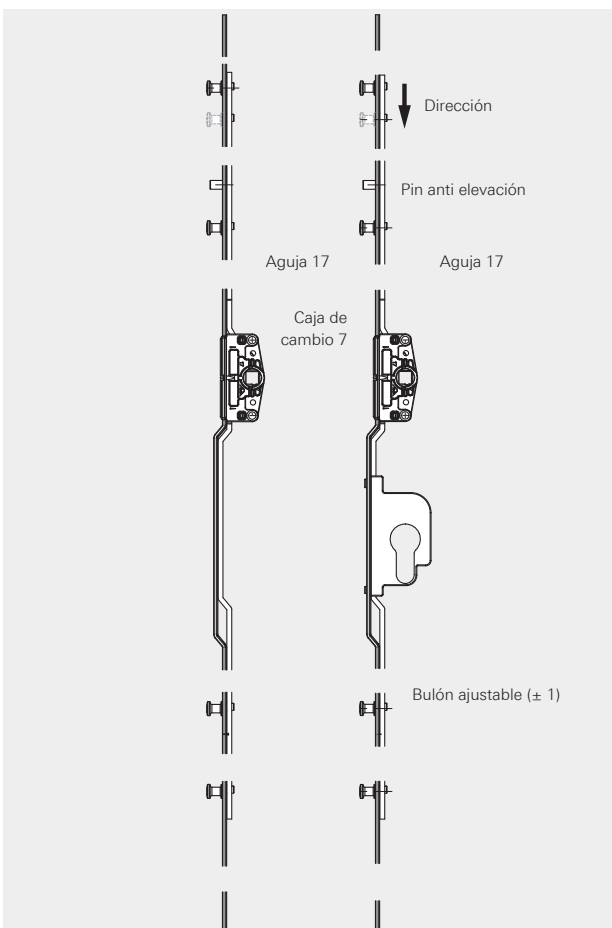

Cremona aguja 17 mm

Rango de aplicación/mm	Largo/mm	Bulones	Mat. Nr.
240 – 400	240	2	628 482
401 – 600	400	2	628 483
601 – 800	600	2	628 484
801 – 1000	800	2	628 495
1001 – 1200	1000	3	628 496
1201 – 1800	1200	3	628 497
1801 – 2900	1800	4	628 498

Cremona aguja 17 mm, con cerradura

Rango de aplicación/mm	Largo/mm	Bulones	Mat. Nr.
1800 – 2900	1800	4	628 499

Cilindros

Ver Página 69



Llaves Virgenes

Descripción	Material no .
Llave Virgen	632626



Cremona monopunto AG 10 mm







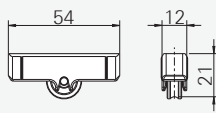



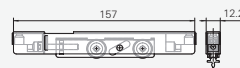

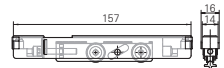
Rango de aplicación/mm	Largo/mm	Bulones	Mat. Nr.
240 – 800	240	1	765 437

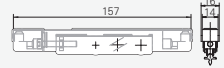

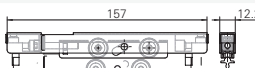
3. Rodamientos

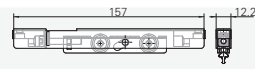
Ruedas simples

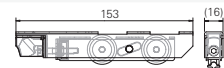
Descripción	Ancho	Alto	Peso	Carril	Mat. nr
Rodamiento simple de altura fija con cuerpo de plástico		12 mm	21 mm	50 Kg	637 617

Ruedas tándem

Descripción	Ancho	Alto	Peso	Carril	Mat. nr
Ruedas tándem estándar ajustables, rodamiento de bolas		12,2mm	19 - 26 mm	120 Kg	 615 951
Ruedas tándem estándar ajustables, rodamiento de bolas		14 mm	19 - 26 mm	120 Kg	 622 876
Ruedas tándem estándar ajustables. Rodamiento de agujas.		14 mm	19 - 26 mm	80 Kg	 312 896
Ruedas tándem estándar ajustables, extraplanas. Rodamiento de agujas.		12,2 mm	15 - 18,5 mm	100 Kg	 312 897
Ruedas tándem estándar ajustables, extraplanas. Rodamiento de agujas.		12,2 mm	15 - 18,5 mm	100 Kg	 297 216
Ruedas tándem estándar ajustables, extraplanas. Rodamiento de bolas		16 mm	23,5 - 28,5mm	200 Kg	 603 430

 R2.5  V

Calzos para ruedas tándem

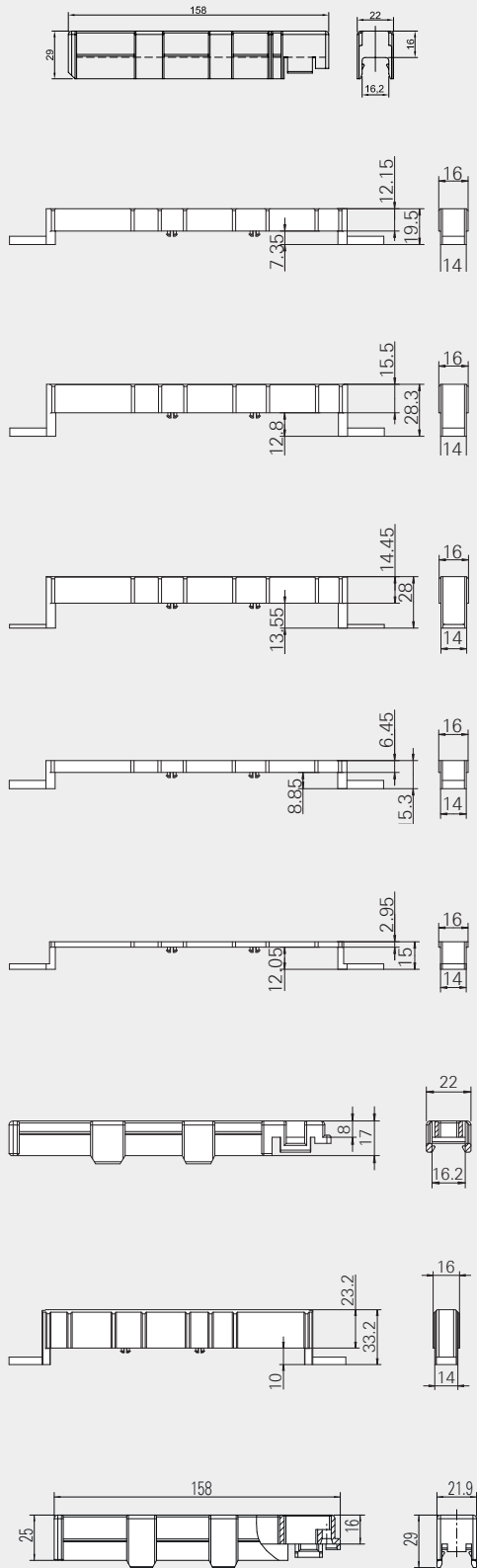

Set calzos para ruedas 200 kgs 603 430

Set calzos P001 603 431

(Aluplast SF73)

Contenido
 2 calzos
 4 tornillos

Set calzos P002 603 432

(Deceuninck Zendow, Marco nr. 3450, Hoja nr. 3465)

Contenido
 2 calzos
 4 tornillos

Set calzos P003 603 433

(Rehau S717, Rehau High slide)

Contenido
 2 calzos
 4 tornillos

Set calzos P004 603 434

(Kömmerling SF2)

Contenido
 2 calzos
 4 tornillos

Set calzos P005 603 535

(Kömmerling SF3)

Contenido
 2 calzos
 4 tornillos

Set calzos P006 606 569

(Schüco S150)

para 22 mm
 canal

Set calzos P007 621 100

(Veka Ekosol 70, Veka Ekosol 90, Tecnocom, Rehau S920)

Contenido
 2 calzos
 4 tornillos

Set calzos P008 634 505

para 22 x 45 mm
 Tuerca

4. Manillas

Manillas RotoLine

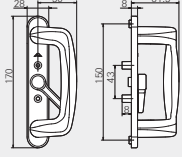
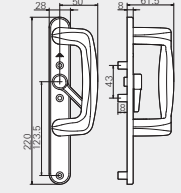
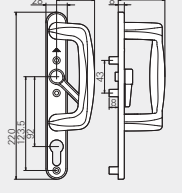
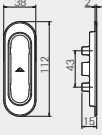
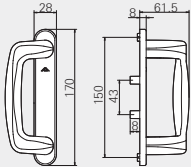
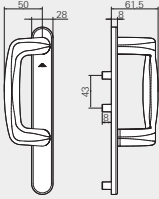
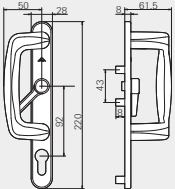
<p>Manilla interior</p>	<p>Sin cerradura con accionador</p>  <table border="1" data-bbox="533 584 772 696"> <thead> <tr> <th>Código</th> <th>Color</th> <th>Mat. Nr.</th> </tr> </thead> <tbody> <tr> <td>R01.5</td> <td>Plata</td> <td>613 222</td> </tr> <tr> <td>R 07.2</td> <td>Blanco</td> <td>613 226</td> </tr> <tr> <td>R 04.1</td> <td>Marrón</td> <td>613 224</td> </tr> <tr> <td>R 06.2</td> <td>Negro</td> <td>613 225</td> </tr> </tbody> </table>	Código	Color	Mat. Nr.	R01.5	Plata	613 222	R 07.2	Blanco	613 226	R 04.1	Marrón	613 224	R 06.2	Negro	613 225	<p>Sin cerradura, placa larga y accionador</p>  <table border="1" data-bbox="852 584 1091 696"> <thead> <tr> <th>Código</th> <th>Color</th> <th>Mat. Nr.</th> </tr> </thead> <tbody> <tr> <td>R 01.5</td> <td>Plata</td> <td>613 230</td> </tr> <tr> <td>R 07.2</td> <td>Blanco</td> <td>613 234</td> </tr> <tr> <td>R 04.1</td> <td>Marrón</td> <td>613 232</td> </tr> <tr> <td>R 06.2</td> <td>Negro</td> <td>613 233</td> </tr> </tbody> </table>	Código	Color	Mat. Nr.	R 01.5	Plata	613 230	R 07.2	Blanco	613 234	R 04.1	Marrón	613 232	R 06.2	Negro	613 233	<p>Con cerradura y accionador</p>  <table border="1" data-bbox="1161 584 1401 696"> <thead> <tr> <th>Código</th> <th>Color</th> <th>Mat. Nr.</th> </tr> </thead> <tbody> <tr> <td>R 01.5</td> <td>Plata</td> <td>613 239</td> </tr> <tr> <td>R 07.2</td> <td>Blanco</td> <td>613 243</td> </tr> <tr> <td>R 04.1</td> <td>Marrón</td> <td>613 241</td> </tr> <tr> <td>R 06.2</td> <td>Negro</td> <td>613 242</td> </tr> </tbody> </table>	Código	Color	Mat. Nr.	R 01.5	Plata	613 239	R 07.2	Blanco	613 243	R 04.1	Marrón	613 241	R 06.2	Negro	613 242
Código	Color	Mat. Nr.																																														
R01.5	Plata	613 222																																														
R 07.2	Blanco	613 226																																														
R 04.1	Marrón	613 224																																														
R 06.2	Negro	613 225																																														
Código	Color	Mat. Nr.																																														
R 01.5	Plata	613 230																																														
R 07.2	Blanco	613 234																																														
R 04.1	Marrón	613 232																																														
R 06.2	Negro	613 233																																														
Código	Color	Mat. Nr.																																														
R 01.5	Plata	613 239																																														
R 07.2	Blanco	613 243																																														
R 04.1	Marrón	613 241																																														
R 06.2	Negro	613 242																																														
<p>Manilla exterior</p> <p>Uñero</p>  <table border="1" data-bbox="229 940 453 1052"> <thead> <tr> <th>Código</th> <th>Color</th> <th>Mat.Nr.</th> </tr> </thead> <tbody> <tr> <td>R 01.5</td> <td>Plata</td> <td>613 183</td> </tr> <tr> <td>R 07.2</td> <td>Blanco</td> <td>605 543</td> </tr> <tr> <td>R 04.1</td> <td>Marrón</td> <td>613 185</td> </tr> <tr> <td>R 06.2</td> <td>Negro</td> <td>605 551</td> </tr> </tbody> </table>	Código	Color	Mat.Nr.	R 01.5	Plata	613 183	R 07.2	Blanco	605 543	R 04.1	Marrón	613 185	R 06.2	Negro	605 551	<p>Utilice el kit de accesorios *Según espesor del perfil</p> <p>Ver Página 58</p>	<p>Utilice el kit de accesorios *Según espesor del perfil</p> <p>Ver Página 58</p>	<p>Utilice el kit de accesorios *Según espesor del perfil</p> <p>Ver Página 58</p>																														
Código	Color	Mat.Nr.																																														
R 01.5	Plata	613 183																																														
R 07.2	Blanco	605 543																																														
R 04.1	Marrón	613 185																																														
R 06.2	Negro	605 551																																														
<p>Tirador sin cerradura</p>  <table border="1" data-bbox="229 1312 453 1424"> <thead> <tr> <th>Código</th> <th>Color</th> <th>Mat. Nr.</th> </tr> </thead> <tbody> <tr> <td>R 01.5</td> <td>Plata</td> <td>613 187</td> </tr> <tr> <td>R 07.2</td> <td>Blanco</td> <td>613 191</td> </tr> <tr> <td>R 04.1</td> <td>Marrón</td> <td>613 189</td> </tr> <tr> <td>R 06.2</td> <td>Negro</td> <td>613 190</td> </tr> </tbody> </table>	Código	Color	Mat. Nr.	R 01.5	Plata	613 187	R 07.2	Blanco	613 191	R 04.1	Marrón	613 189	R 06.2	Negro	613 190	<p>Utilice el kit de accesorios *Según espesor del perfil</p> <p>Ver Página 58</p>	<p>Utilice el kit de accesorios *Según espesor del perfil</p> <p>Ver Página 58</p>	<p>Utilice el kit de accesorios *Según espesor del perfil</p> <p>Ver Página 58</p>																														
Código	Color	Mat. Nr.																																														
R 01.5	Plata	613 187																																														
R 07.2	Blanco	613 191																																														
R 04.1	Marrón	613 189																																														
R 06.2	Negro	613 190																																														
<p>Tirador sin cerradura con placa larga</p>  <table border="1" data-bbox="229 1675 453 1787"> <thead> <tr> <th>Código</th> <th>Color</th> <th>Mat. Nr.</th> </tr> </thead> <tbody> <tr> <td>R 01.5</td> <td>Plata</td> <td>613 195</td> </tr> <tr> <td>R 07.2</td> <td>Blanco</td> <td>613 199</td> </tr> <tr> <td>R 04.1</td> <td>Marrón</td> <td>613 197</td> </tr> <tr> <td>R 06.2</td> <td>Negro</td> <td>613 198</td> </tr> </tbody> </table>	Código	Color	Mat. Nr.	R 01.5	Plata	613 195	R 07.2	Blanco	613 199	R 04.1	Marrón	613 197	R 06.2	Negro	613 198	<p>Utilice el kit de accesorios *Según espesor del perfil</p> <p>Ver Página 58</p>	<p>Utilice el kit de accesorios *Según espesor del perfil</p> <p>Ver Página 58</p>	<p>Utilice el kit de accesorios *Según espesor del perfil</p> <p>Ver Página 58</p>																														
Código	Color	Mat. Nr.																																														
R 01.5	Plata	613 195																																														
R 07.2	Blanco	613 199																																														
R 04.1	Marrón	613 197																																														
R 06.2	Negro	613 198																																														
<p>Tirador con cerradura y accionador</p>  <table border="1" data-bbox="229 2029 453 2141"> <thead> <tr> <th>Código</th> <th>Color</th> <th>Mat. Nr.</th> </tr> </thead> <tbody> <tr> <td>R 01.5</td> <td>Plata</td> <td>613 203</td> </tr> <tr> <td>R 07.2</td> <td>Blanco</td> <td>613 217</td> </tr> <tr> <td>R 04.1</td> <td>Marrón</td> <td>613 215</td> </tr> <tr> <td>R 06.2</td> <td>Negro</td> <td>613 216</td> </tr> </tbody> </table>	Código	Color	Mat. Nr.	R 01.5	Plata	613 203	R 07.2	Blanco	613 217	R 04.1	Marrón	613 215	R 06.2	Negro	613 216			<p>Utilice el kit de accesorios *Según espesor del perfil</p> <p>Ver Página 58</p>																														
Código	Color	Mat. Nr.																																														
R 01.5	Plata	613 203																																														
R 07.2	Blanco	613 217																																														
R 04.1	Marrón	613 215																																														
R 06.2	Negro	613 216																																														

Kits de accesorios manillas RotoLine Corrediza

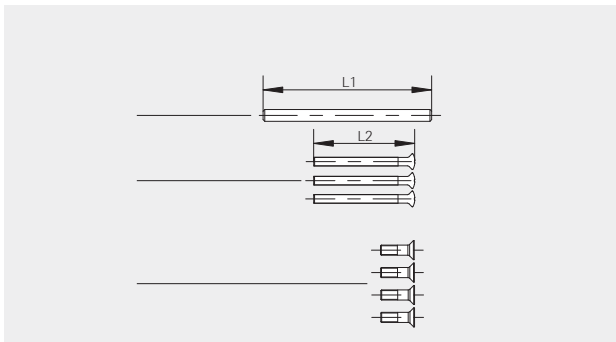

Kit Accesorios

Profundidad del perfil de la hoja (mm)	L1 (mm)	L2 (mm)	Mat. Nr..
68 – 77	100	80	613 178
38 – 47	70	50	613 181

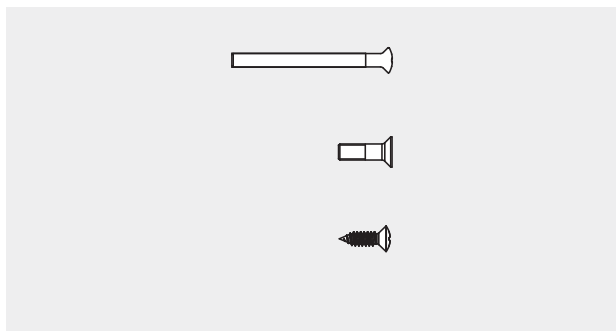

Función de los diferentes tornillos

Para atornillar el interior y el exterior de las manillas entre sí.

Para la fijación del tirador a la placa.

Para el agujero del tornillo inferior, si la manilla corta y larga se combinan.

Cilindros

Ver Página 69



Llaves Virgenes

Descripcion	Material no .
Llave Virgen	632626

Manillas Pop-up estándar 26/d =11

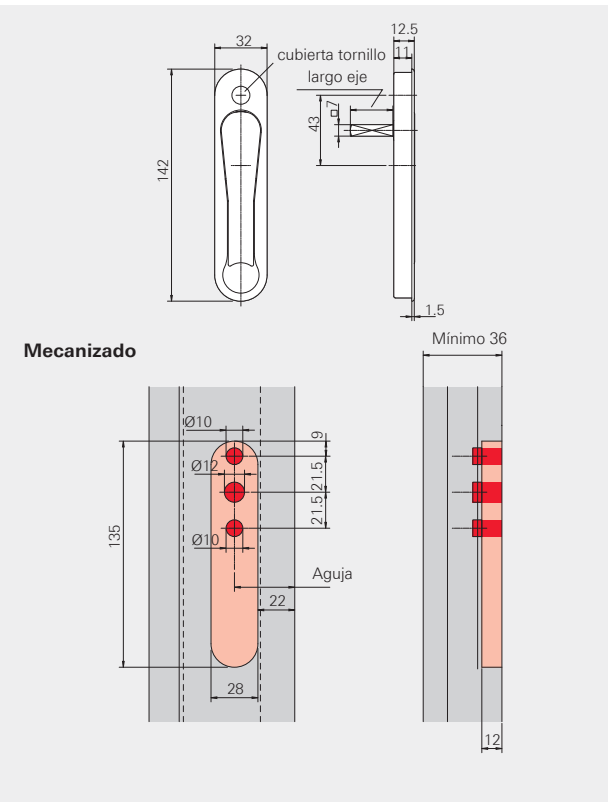

Manilla Pop-up

Código	Color	Color cubierta	Material nr.
R 04.1	Marrón		323 277

Manilla Pop-up, Eje 45 mm

Código	Color	Color cubierta	Material nr.
R 06.2	Negro, RAL 9005	negro	561 198

Manillas Pop-up estándar 26,5/d=8

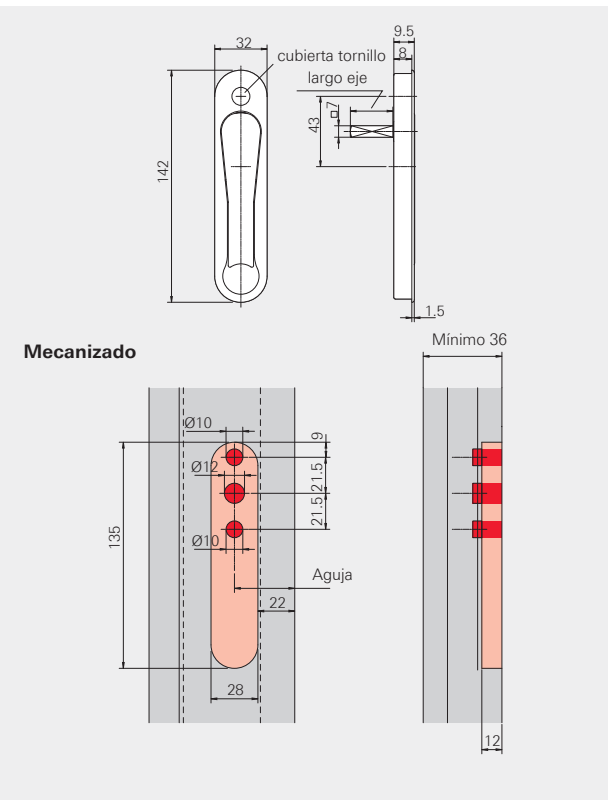

Manilla Pop-up, Eje 26 mm

Código	Color	Material nr.
R 07.2	Blanco RAL 9016	570 810
R 01.1	Gris	637 963
R 06.2	Negro	614 295

Manillas RotoLine cuadradillo 30 mm- sin logotipo Roto

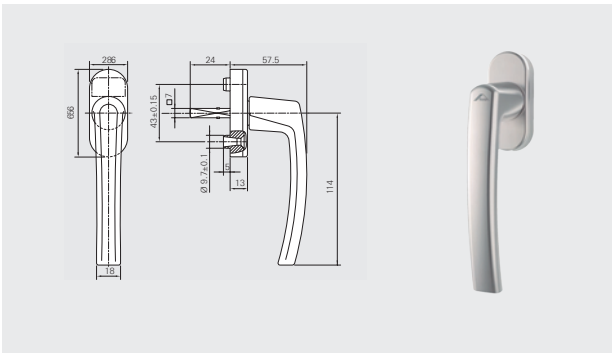

Manilla RotoLine cuadradillo 30 mm

Código	Color	Material nr.
R 01.1	Plata	228 079
R 07.2	Blanco, RAL 9016	228 176
R 04.1	Marrón	482 542
	Titán	339 532
R 06.2	Negro	494 014

Manillas Roto Line Con Llave

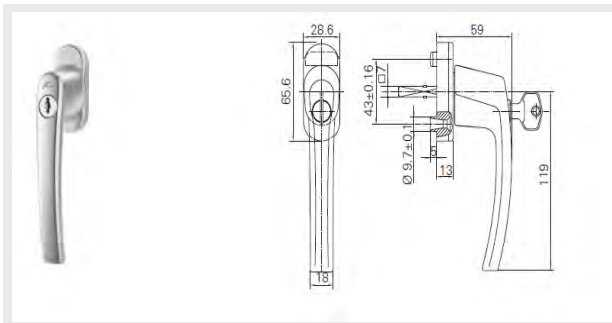

Manilla Roto Line c/ llave RotoLine, cuadradillo 35 mm

Color	Material nr.
Blanco	228 043
Marrón	228 042
Titan	228 040

Manilla Rotoline plana

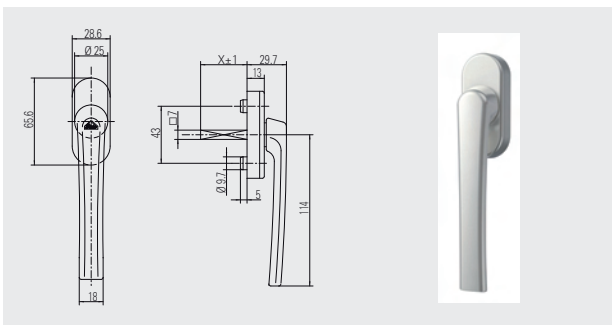

30 Manillas RotoLine Plana

Descripción	Nr. Material
Blanca	336 110
Bronce	336 111
Plata	336 112
Marron Oscuro	490 462

5. Cerraderos

Descripción	Aguja Cremona	Referencia	
		Mano Derecha	Mano Izquierda
Aluplast 60	7	629 559	
Aluplast 80	17	348 598	
Kommerling SF2 PREMILINE	17	629 518	629 516
Kommerling SF3	7	245 248	
Rehau Euroslide Hoja 1	7	771 377	
Rehau Euroslide Hoje 2	17	771 377	
Tecnocom 1010	17	771 376	
Tecnocom 1011	7	771 376	
Tecnocom 1012	7	771 376	
Veka SL CD Hoja 105.322	7	771 376	
Veka SL CD Hoja 105.321	17	771 376	
Veka SL58CD	7	771 376	

Accesorios

Buffer stop

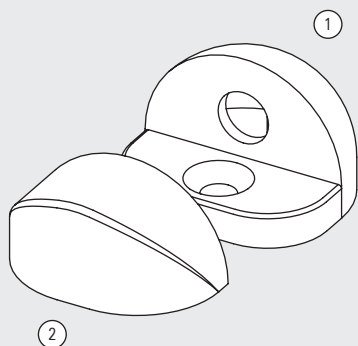

1 + 2 Buffer stop (incluye pieza de goma, sin tornillos)

Código	Color	Material nr.
R 06.2	negro, RAL 9005	335 555
R 07.2	blanco traffic, RAL 9016	317 250
	blanco aluminio RAL 9006	449 963

1 Buffer stop (sin pieza de goma)

Código	Color	Material nr.
	sin revestimiento	317 249

2 Pieza de goma

Código	Color	Material nr.
R 06.2	negro, RAL 9005	317 252

Anti-falsa maniobra

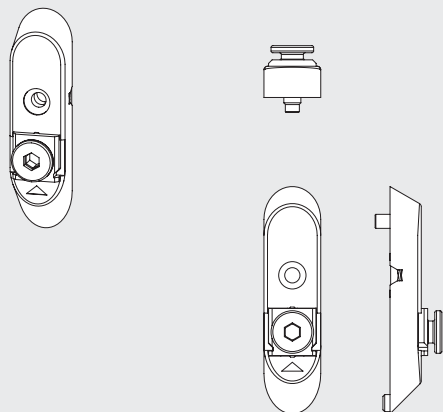

Anti-falsa maniobra 343 733

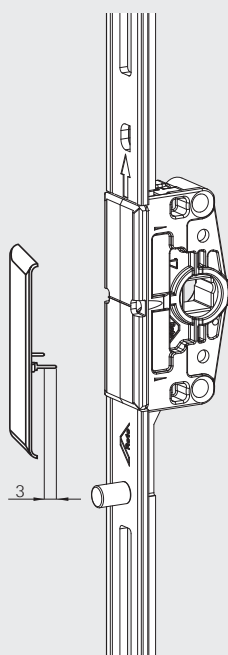

Info-clip

Impresión	Color primario	
Blank	R06.2 negro	230 694
Blank	R07.1/2 blanco	230 696
Impresión UniColor	R06.2 negro	230 692
Impresión UniColor	R07.1/2 blanco	230 695
Impresión BiColor	R07.1/2 blanco	230 697

Rango de aplicación:

Aplicables a todas las cremonas de acción simple.